

# WIRING DIAGRAM

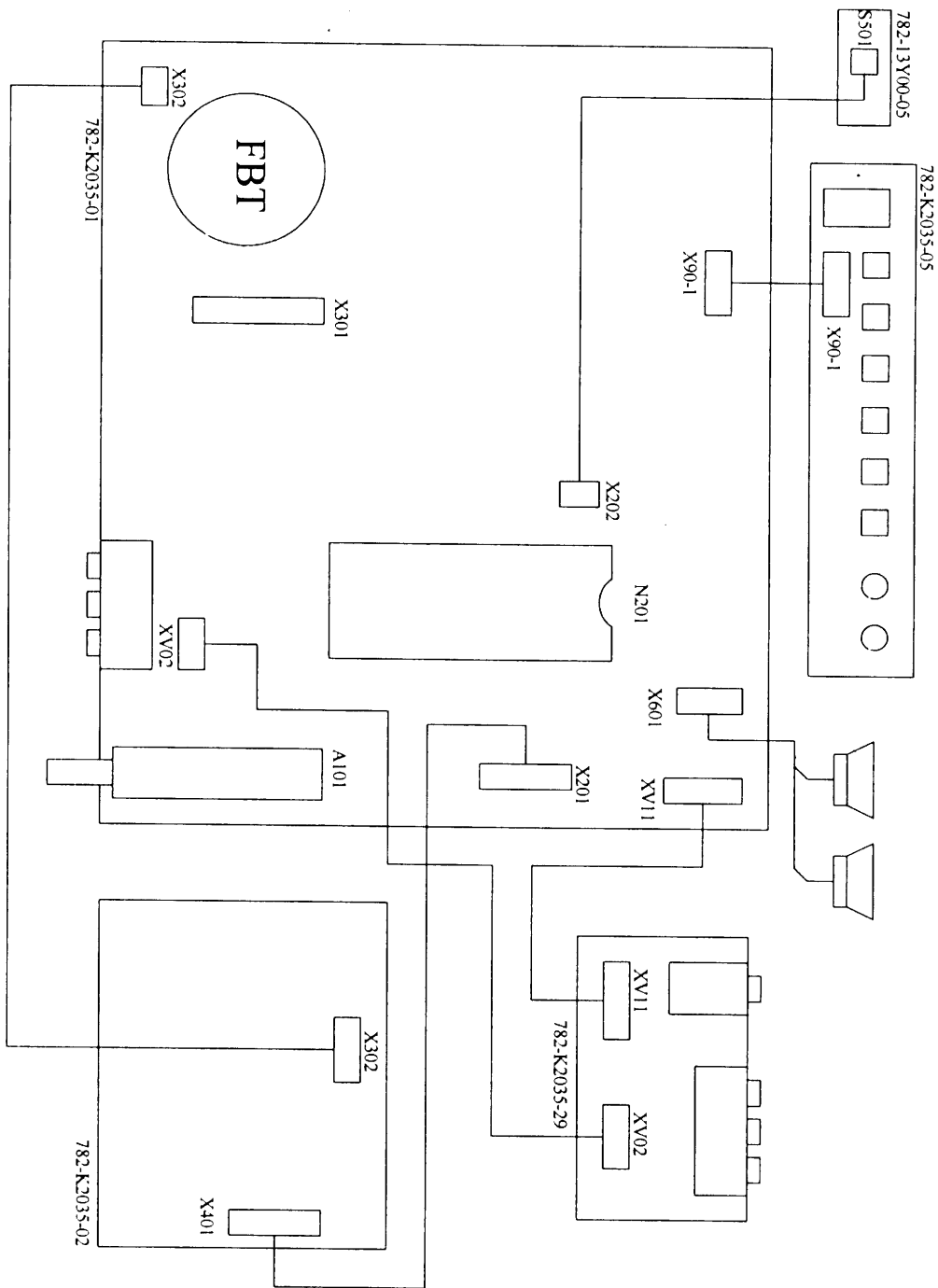

# BLOCK DIAGRAM

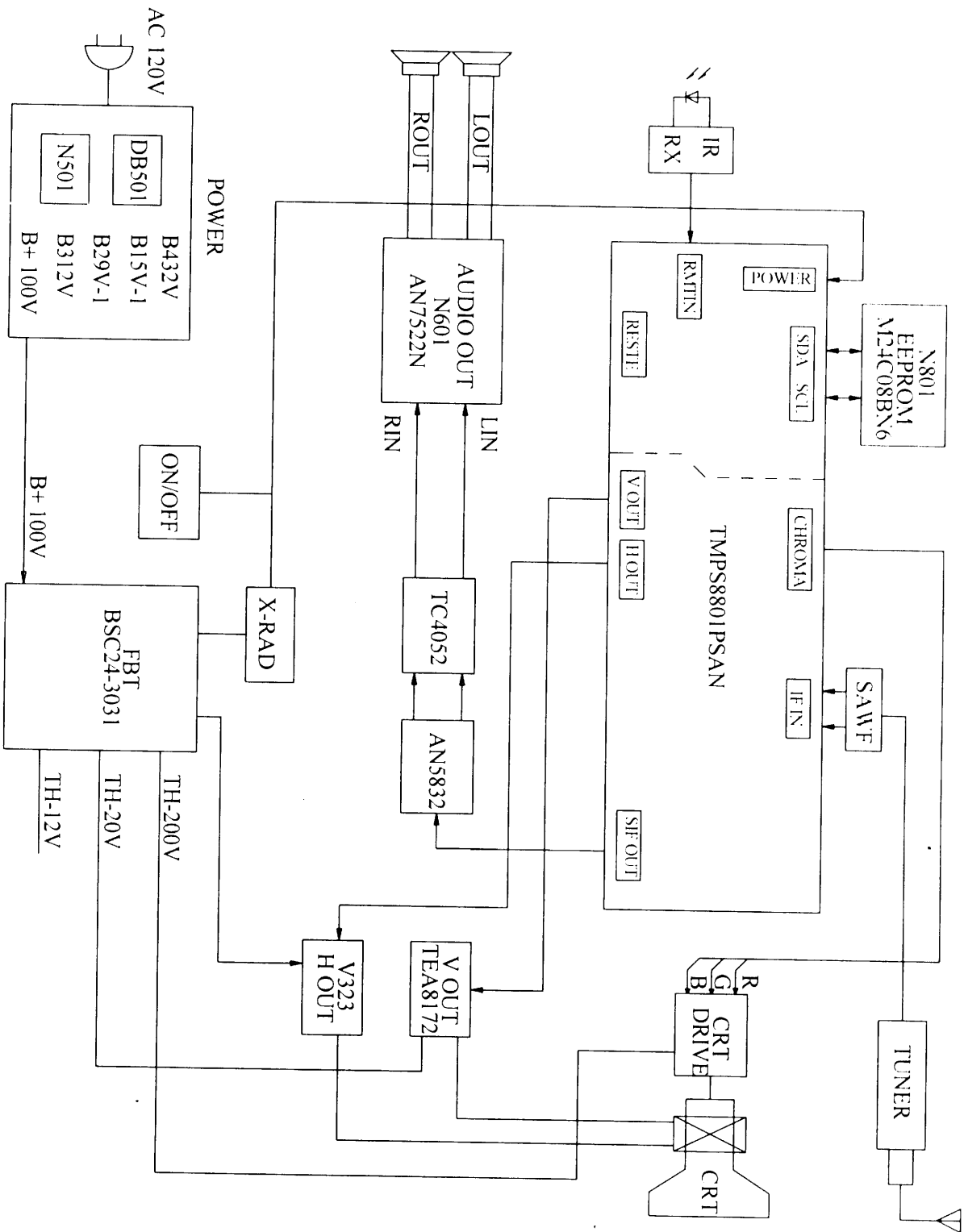

NTSC  
2001.11.26

# SCHEMATIC DIAGRAM

782-K2035-0100

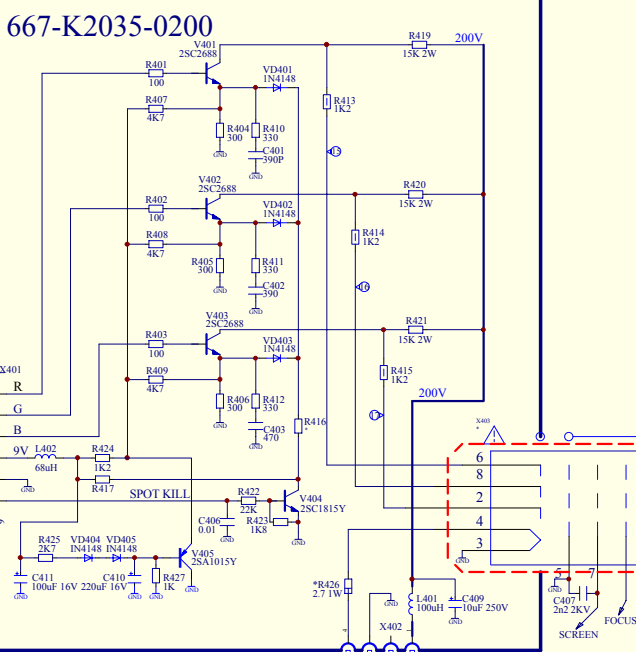
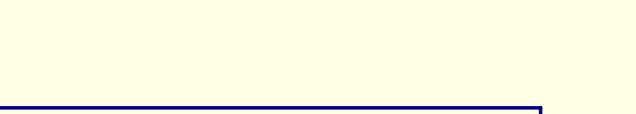
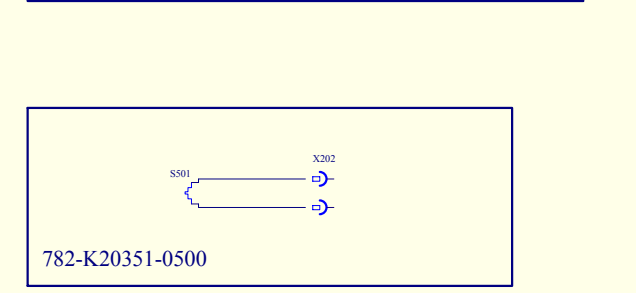
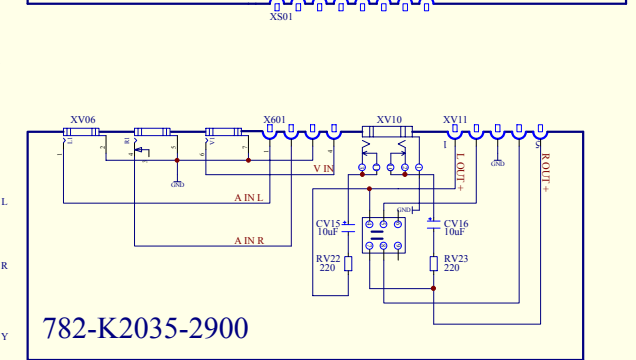
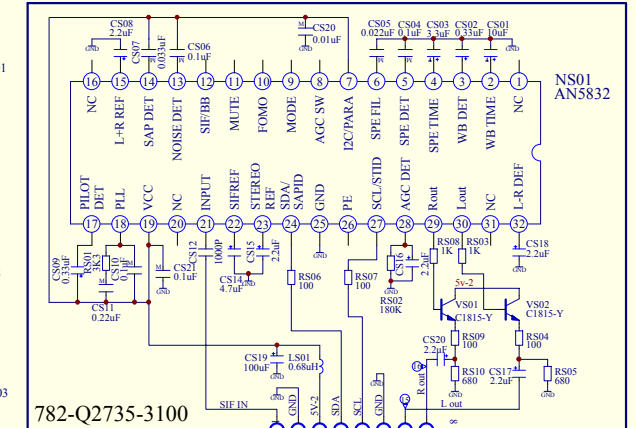
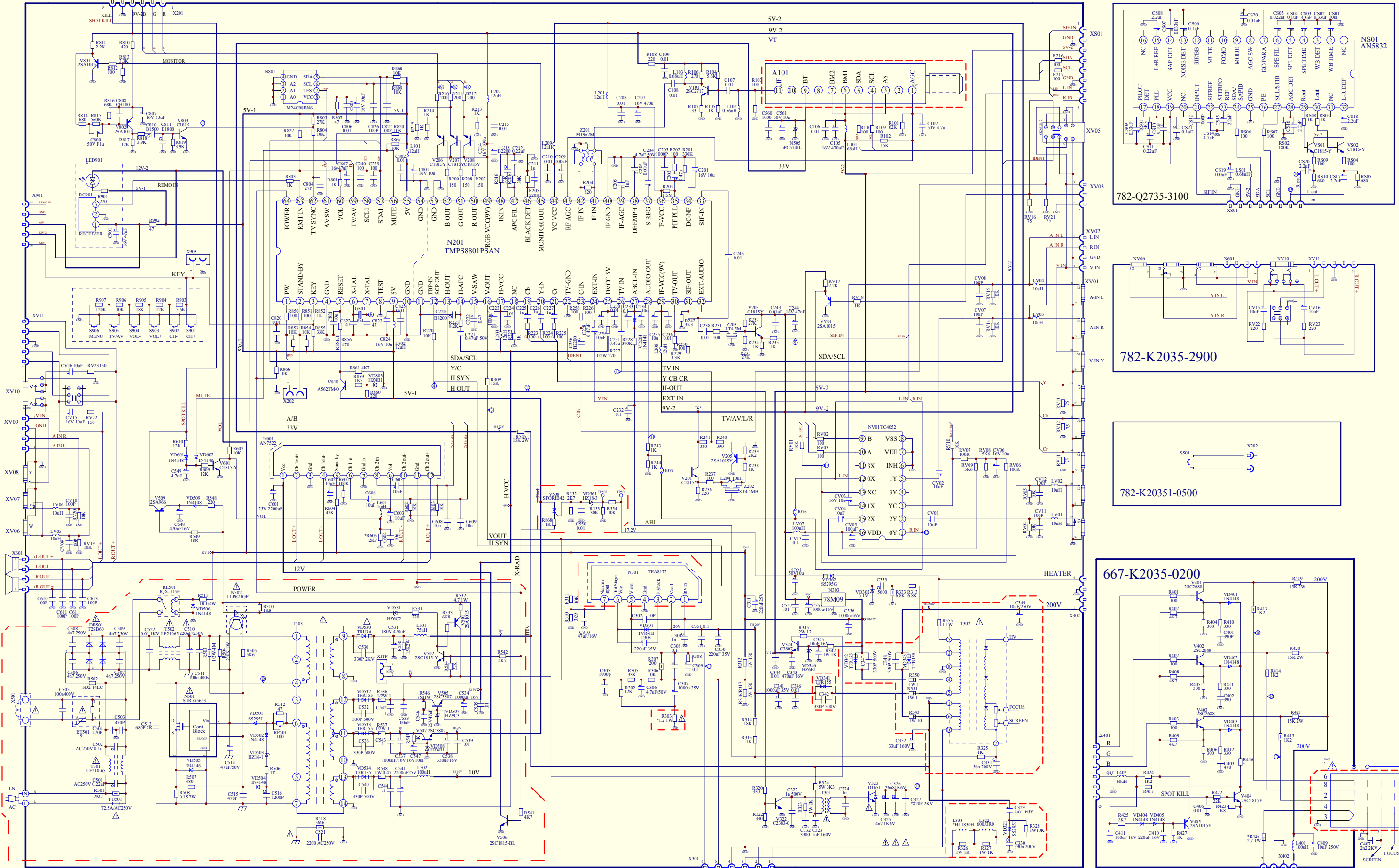

2002.04.22

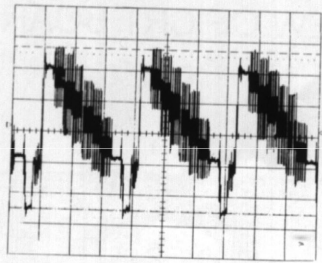

(1) 1V<sub>p,p</sub>

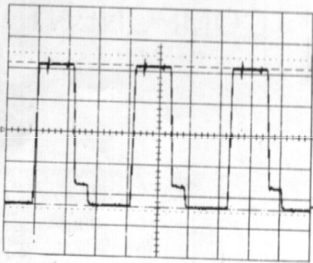

(2) 4.5V<sub>p,p</sub>

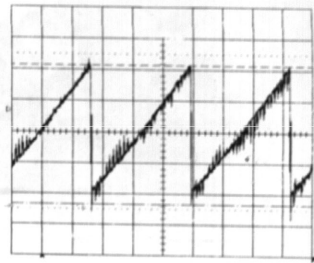

(3) 2.2V<sub>p,p</sub>

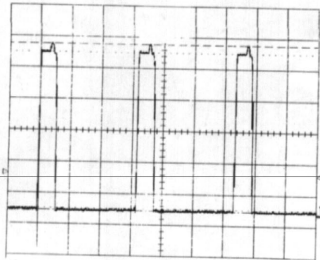

(4) 5.3V<sub>p,p</sub>

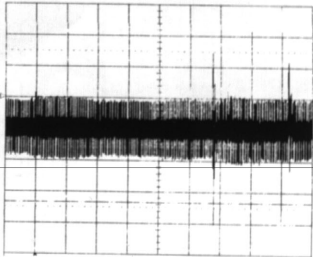

(5) 200mV<sub>p,p</sub>

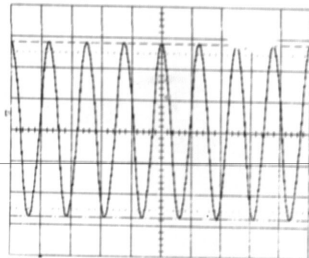

(6) 5.5V<sub>p,p</sub>

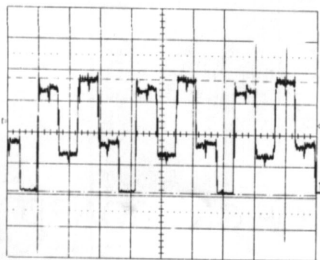

(7) 3.6V<sub>p,p</sub>

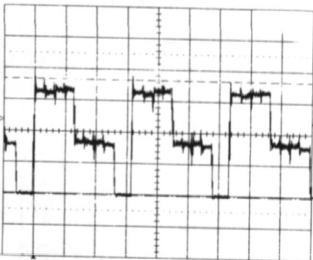

(8) 3.7V<sub>p,p</sub>

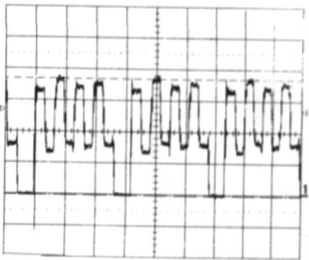

(9) 3.7V<sub>p,p</sub>

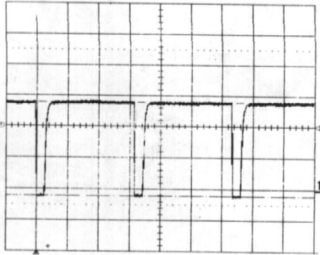

(10) 6V<sub>p,p</sub>

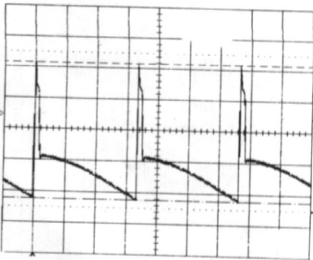

(11) 44V<sub>p,p</sub>



(12) 862V<sub>p,p</sub>

(14) 1.6V<sub>p,p</sub>(L)

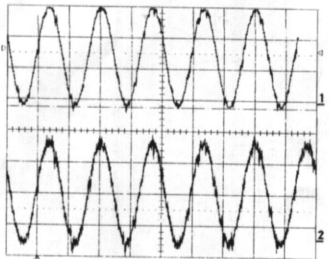

(13) 1.86V<sub>p,p</sub>(R)

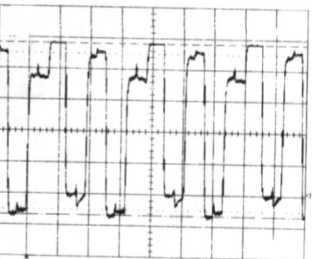

(15) 110V<sub>p,p</sub>



(16) 101V<sub>p,p</sub>

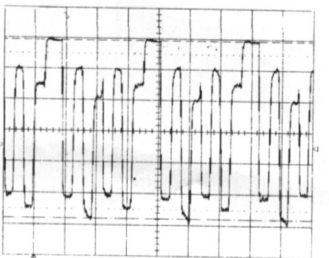

(17) 114V<sub>p,p</sub>



(18) 444V<sub>p,p</sub>